

Article number: 2307030611

Description: E+G Solid handwheel
VDC.140-GXX2+I

Measures

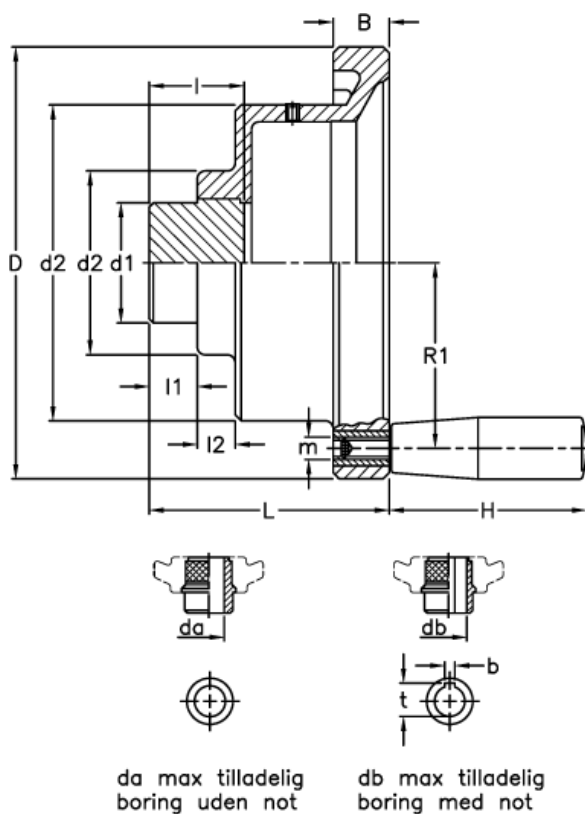

$b = 6$	$H = 65$
$B = 17$	$l = 25$
$D = 140$	$L = 65$
$d_1 = 30$	$l_1 = 12$
$d_2 = 50$	$l_2 = 9.0$
$d_3 = 82$	$m = M8$
$d_a = 25$	$R_1 = 60.0$
$d_b = 20$	$t = 22.8$